



















Select - Instruções de operação















Instruções de segurança

-  Leia este manual atentamente antes de utilizar o aparelho pela primeira vez. Guarde as instruções para utilizações posteriores.
- 

Avisos !

-  Não utilize o aparelho sem que o respetivo saco e filtros estejam devidamente colocados.
-  Não utilize o aparelho para aspirar materiais perigosos ou gases. Se o fizer poderá estar a colocar pessoas em risco de saúde grave.
-  Não utilize o aparelho para aspirar água ou outros líquidos.
-  Não aspire objetos pontiagudos ou cortantes, tais como agulhas ou pedaços de vidro.
-  Não aspire nada que esteja em combustão como, por exemplo, cigarros, fósforos ou cinzas quentes.
-  Utilize e guarde o aparelho em espaços interiores e em ambientes secos, entre os 0 °C e os 60 °C.
-  Não utilize o aparelho no exterior.
-  É necessário cuidado ao utilizar a função de enrolador de cabo, uma vez que a ficha na extremidade do cabo elétrico pode virar subitamente durante a última parte do processo. É aconselhável segurar o cabo enquanto este está a ser enrolado.
-  Não manuseie o aparelho com as mãos molhadas.
-  Desligue o aparelho antes de o desligar da corrente.
-  Para desligar o aparelho da corrente, puxe a ficha, não o cabo. Não transporte ou puxe o aparelho pelo cabo.
-  Não utilize o aparelho se o cabo estiver danificado. Inspeccione regularmente o cabo quanto a danos, especialmente se o cabo tiver sido comprimido, entalado numa porta ou pisado.
-  Não utilize o aparelho se este parecer danificado. Submeta o aparelho a uma inspeção num centro de assistência técnica caso este tenha caído, esteja danificado, tenha ficado no exterior ou tenha sido exposto a água.
-  Não faça alterações ou modificações aos dispositivos de segurança mecânicos ou elétricos.
-  Todas as reparações devem ser efetuadas por um centro de assistência técnica autorizado.
-  Utilize apenas sacos, filtros e acessórios originais do seu distribuidor local. A utilização de sacos e filtros não autorizados anula a garantia.
-  Desligue o aparelho no botão e na tomada antes de trocar o saco ou o filtro. Puxe a ficha, não o cabo.

-  Se o cabo de alimentação estiver danificado, o mesmo tem de ser substituído pelo fabricante, pelo seu fornecedor ou técnico igualmente qualificado a fim de evitar riscos.
-  Não toque em peças em rotação ao utilizar o bocal turbo.
-  Este aparelho pode ser utilizado por crianças a partir dos 8 anos de idade e por pessoas com capacidades físicas, sensoriais ou mentais reduzidas ou sem experiência, caso estas sejam supervisionadas ou lhes seja indicado como utilizar o aparelho em segurança e se estas compreenderem os riscos envolvidos.
-  Não deixe que crianças procedam à limpeza do aparelho ou executem a sua manutenção sem supervisão.
-  As crianças têm de ser supervisionadas para que não haja a possibilidade de brincarem com o aparelho.
-  Não carregue pilhas não recarregáveis.
-  Remova as pilhas recarregáveis do aparelho antes do carregamento.
-  Não misture diferentes tipos de pilhas ou pilhas novas e usadas.
-  Tome atenção à polaridade correta ao introduzir as pilhas.
-  Remova pilhas descarregadas do aparelho e elimine-as de forma segura.
-  Se não utilizar o aparelho durante um longo período de tempo, remova as pilhas.
-  Não coloque os terminais de alimentação em curto-circuito.

Assistência e manutenção

Armazene o aparelho num espaço interior e em ambiente seco.

- Mude o pré-filtro a cada quatro sacos.
- Limpe a superfície da máquina com um pano seco ou ligeiramente humedecido com produto de limpeza.
- Compre acessórios originais num distribuidor local.
- Para obter assistência, contacte apenas o seu distribuidor local.

Responsabilidade

A Nilfisk não se responsabiliza por quaisquer danos resultantes de uma utilização incorreta ou de modificações efetuadas ao aparelho. Consulte o nosso site em www.nilfisk.com para obter mais instruções e informações sobre a utilização.

WEEE

O símbolo  indica que este aparelho não pode ser eliminado em conjunto com o lixo doméstico, mas em separado. Elimine os seus aparelhos antigos colocando-os nos pontos de recolha de reciclagem.

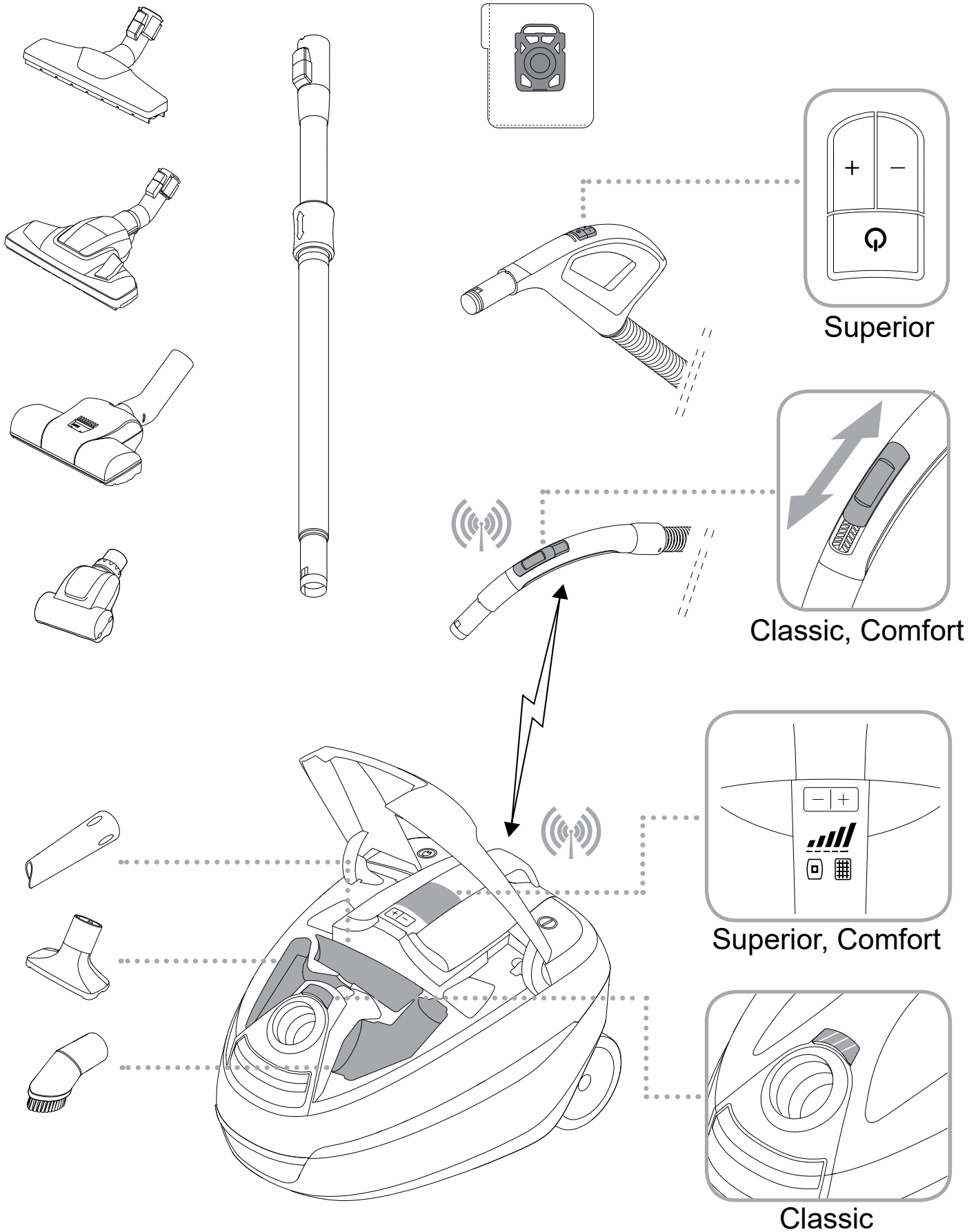

Os tipos de bocais incluídos pode variar de modelo para modelo.

A 

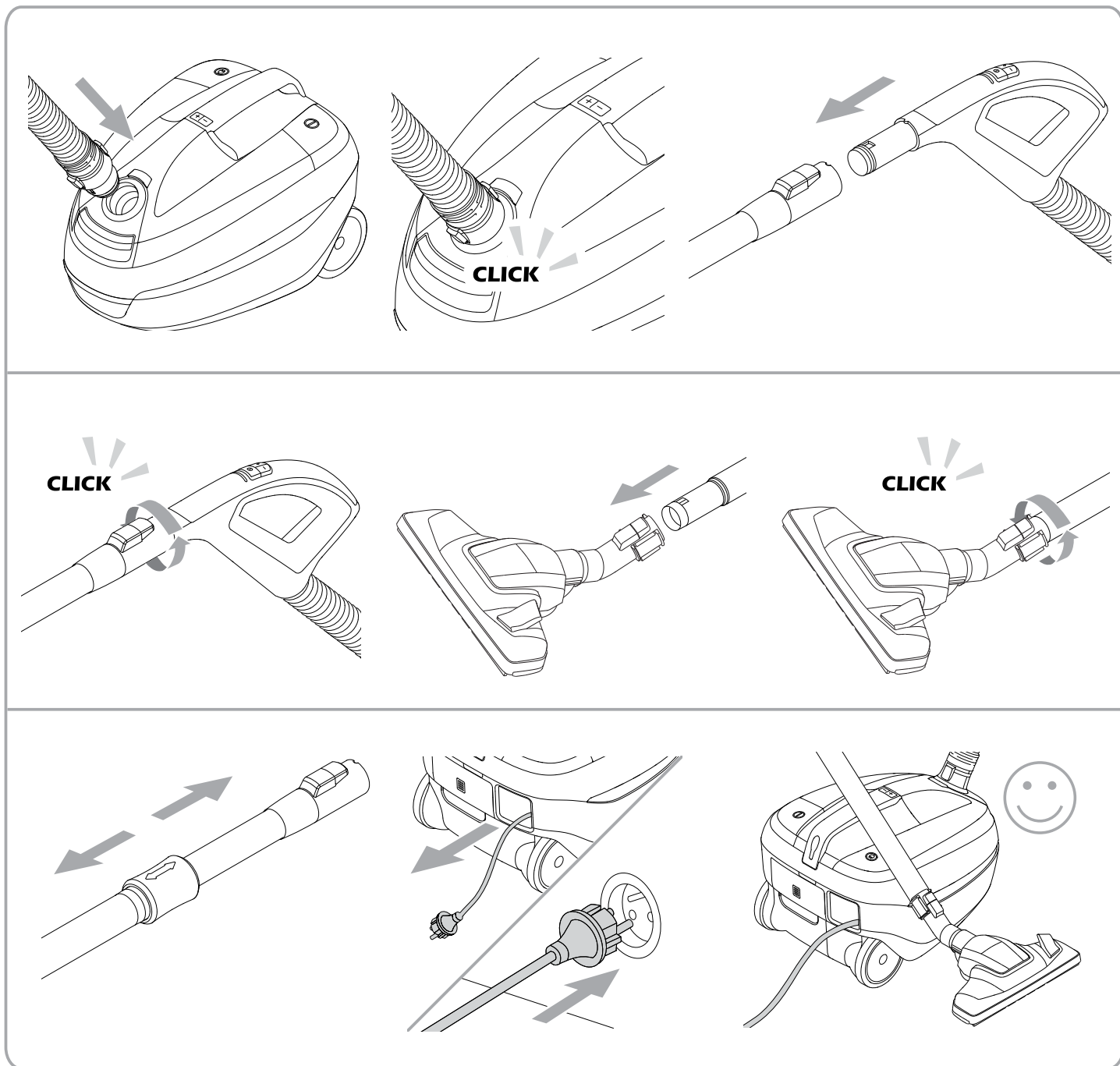

B 

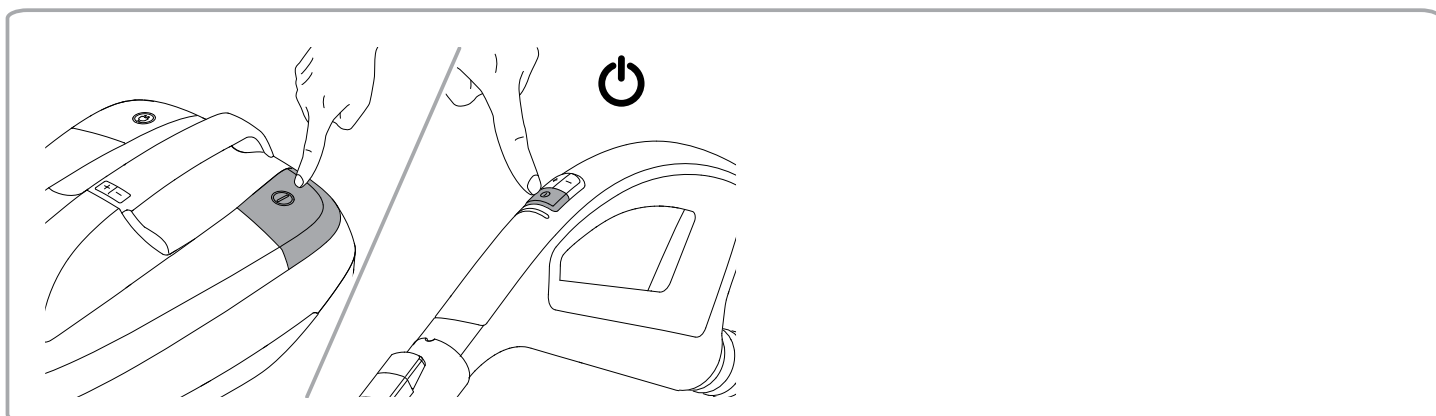

C

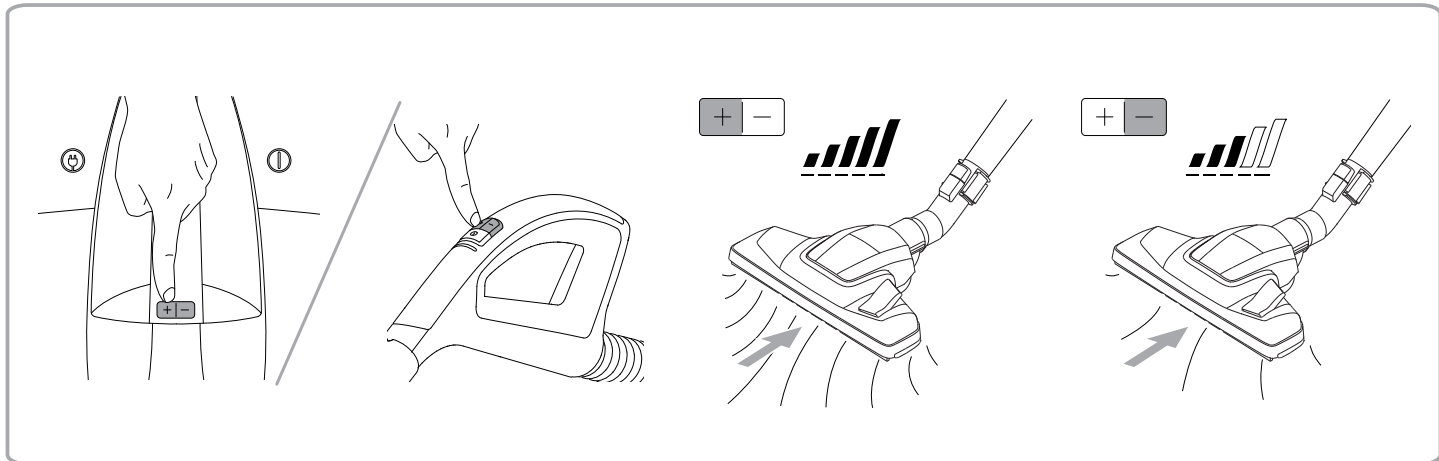

D

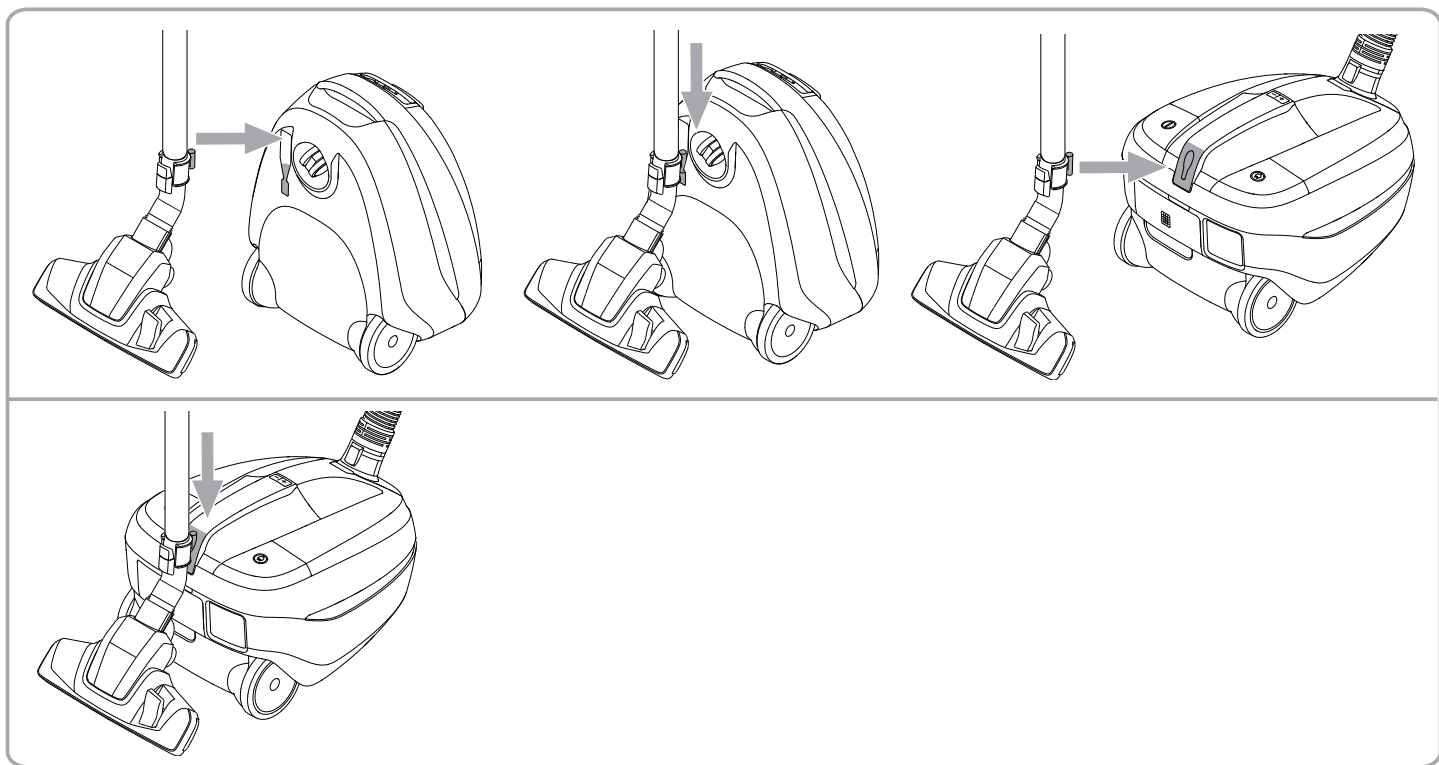

E

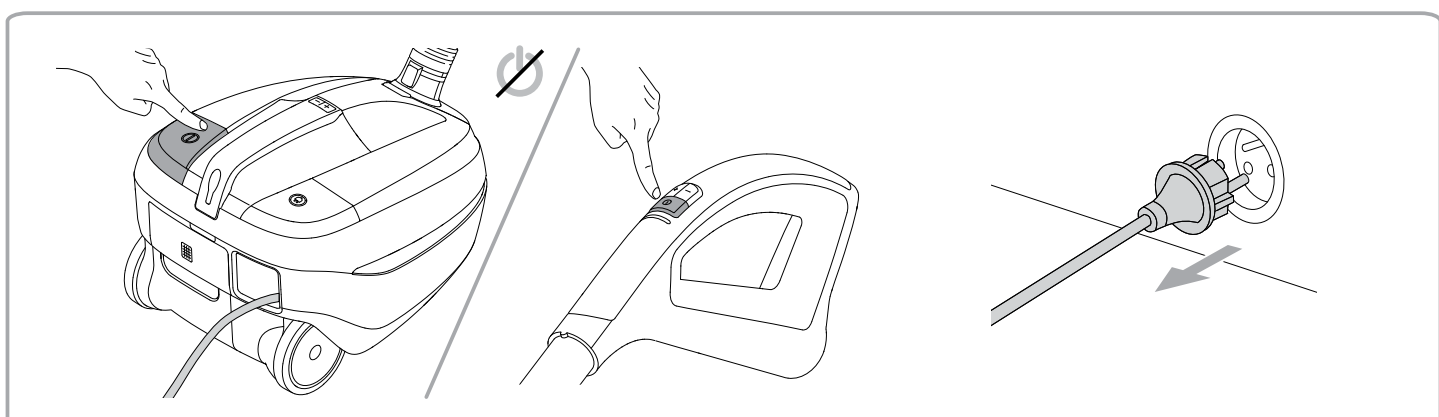

E

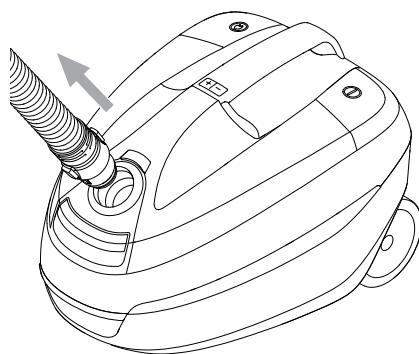
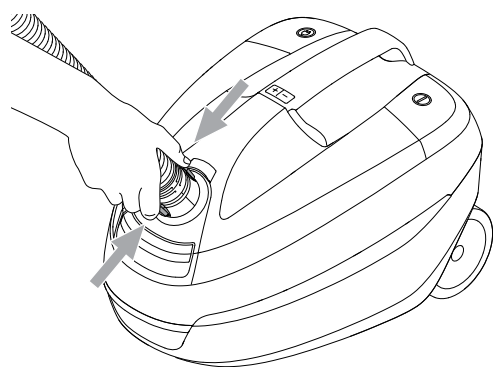
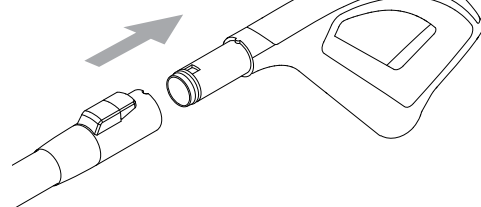
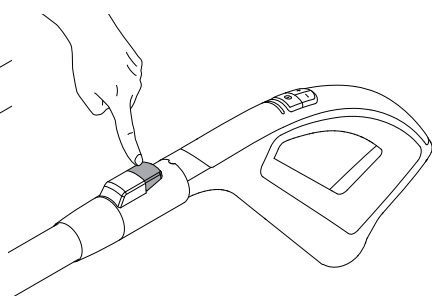
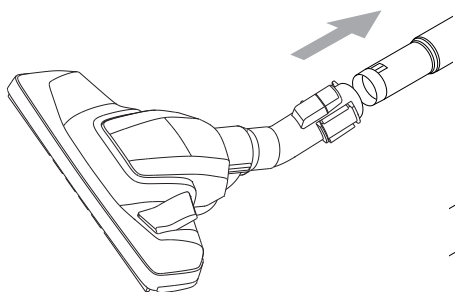
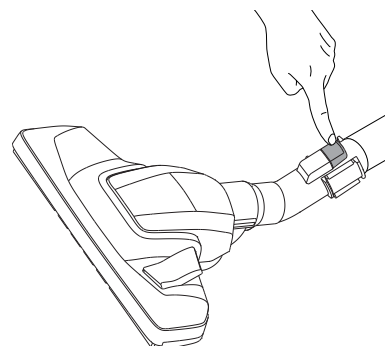
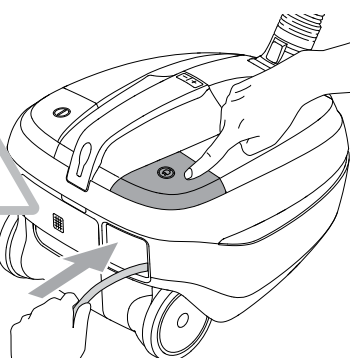
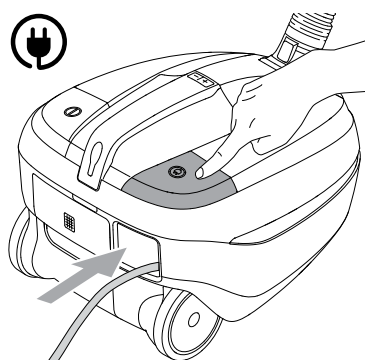

F

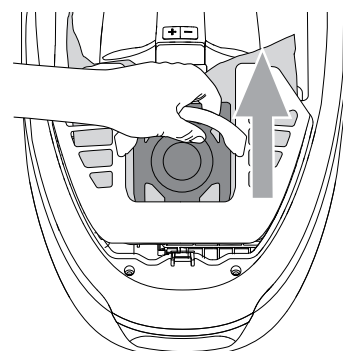
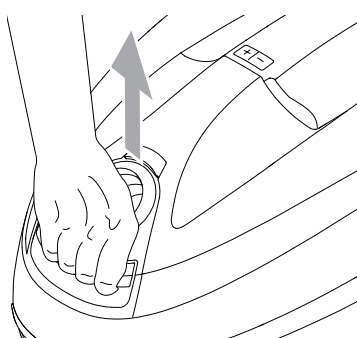
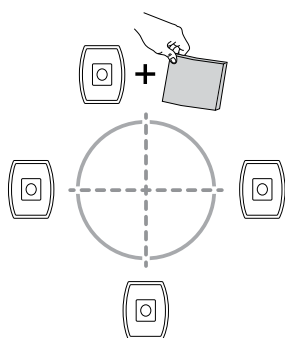

F

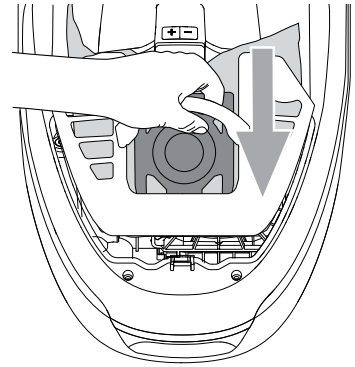
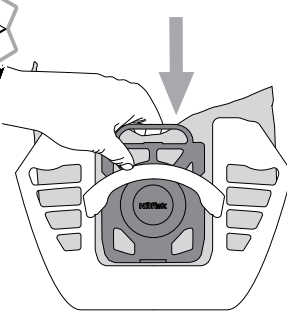
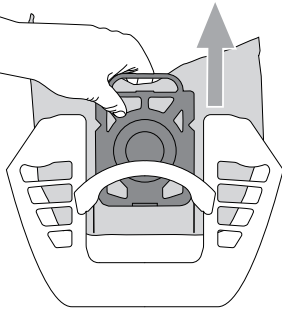

G

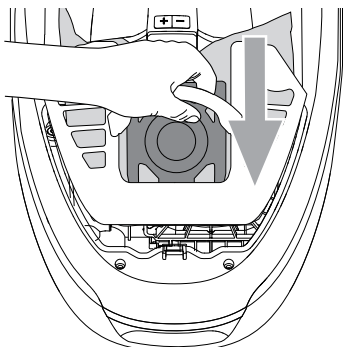
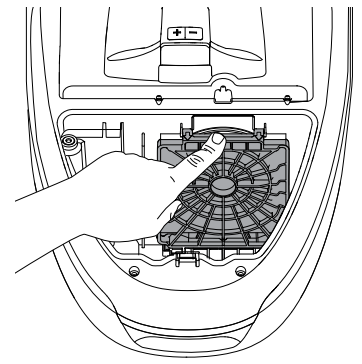
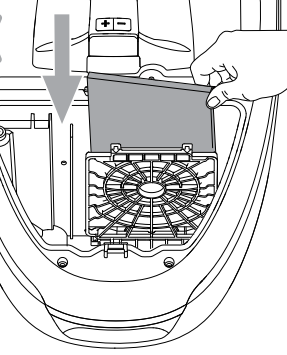
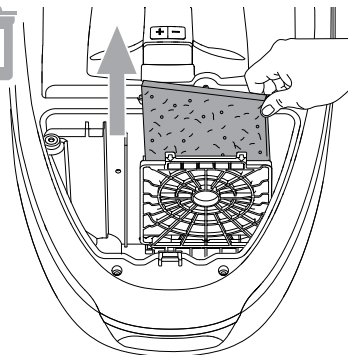
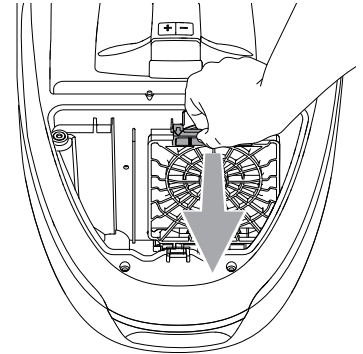
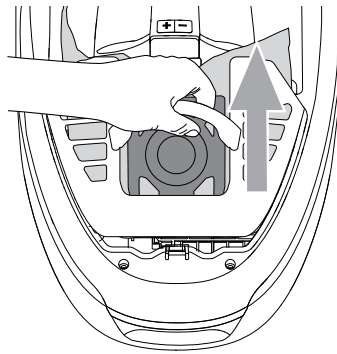
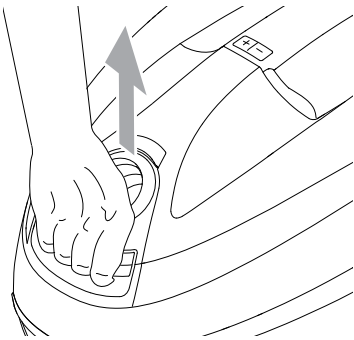

H

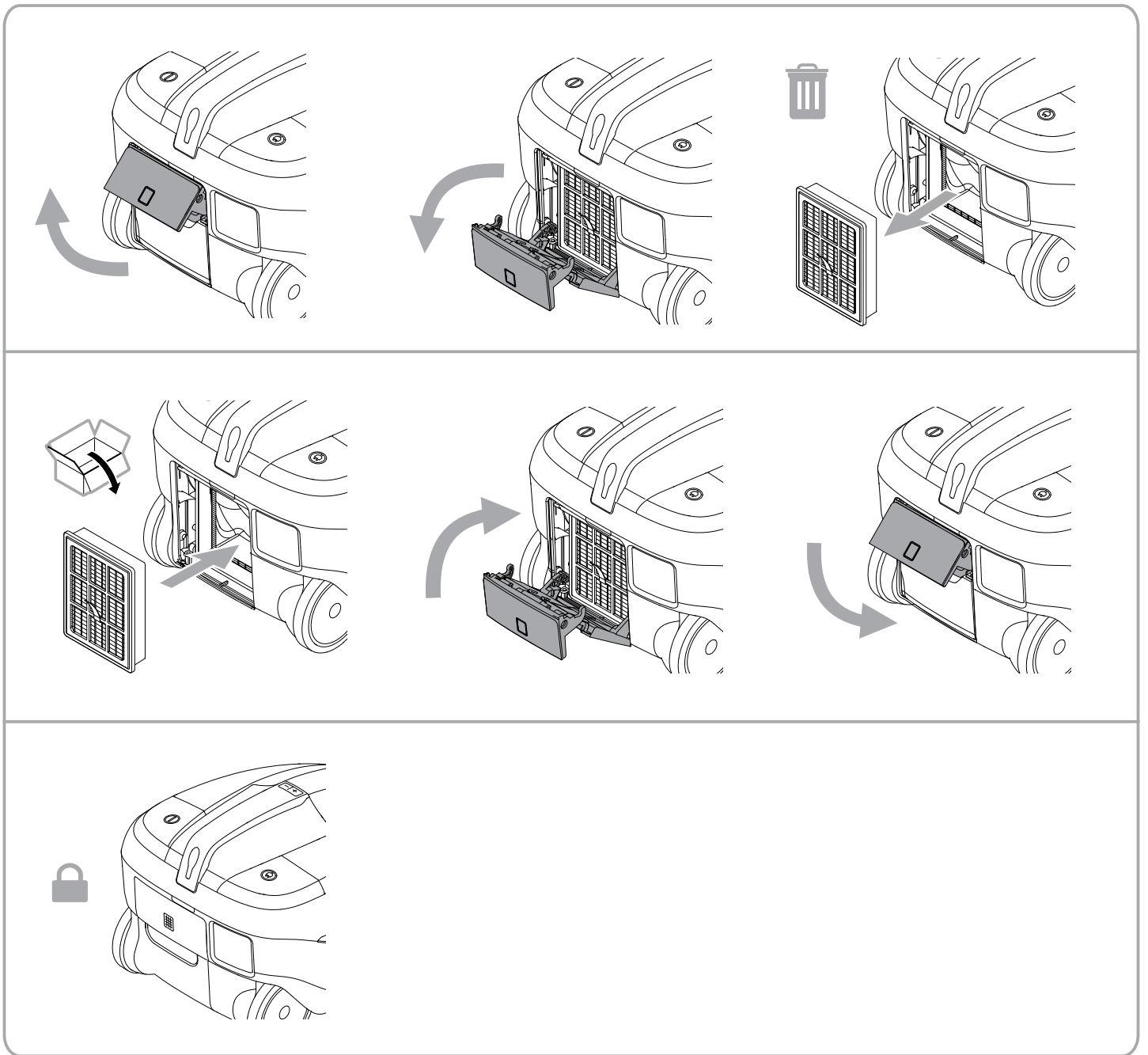

I

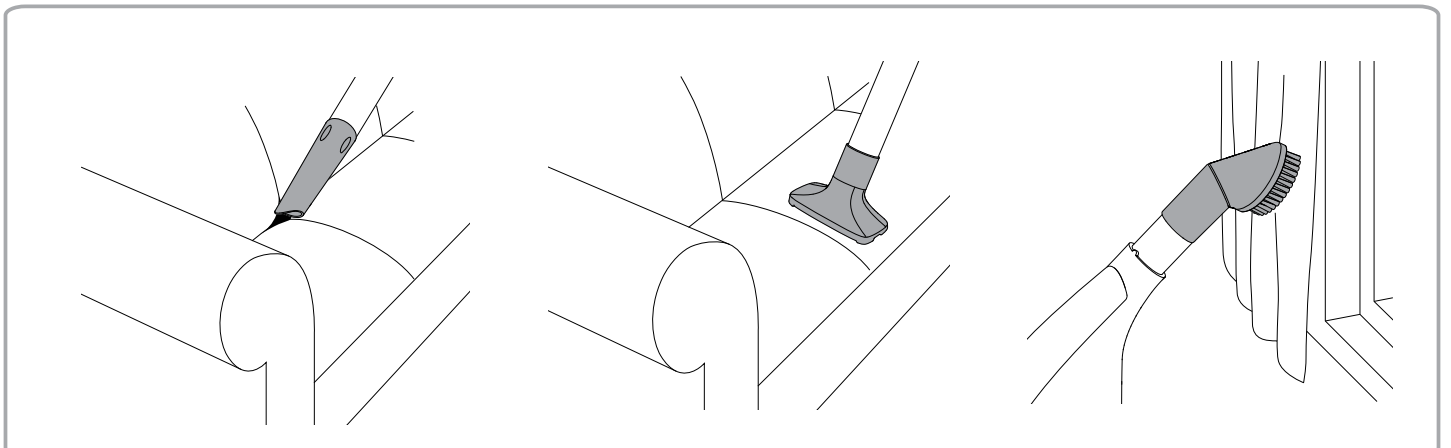

I 

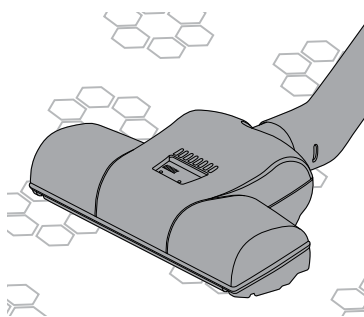
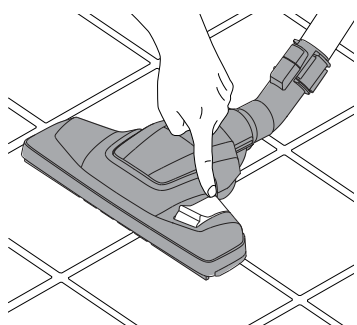
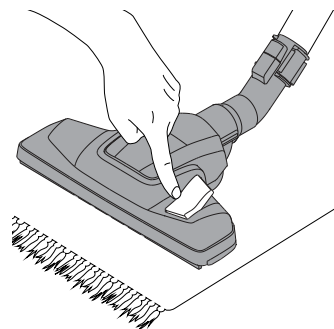
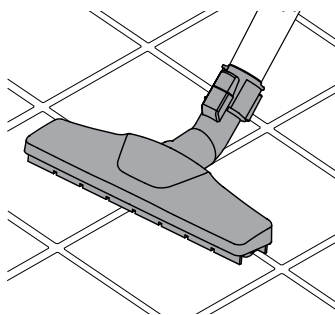
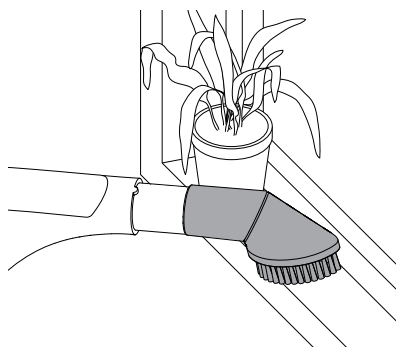

J 

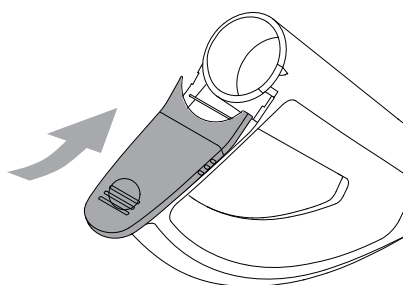
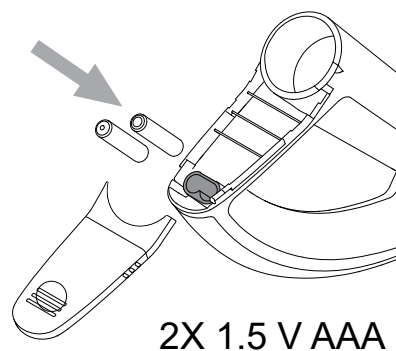
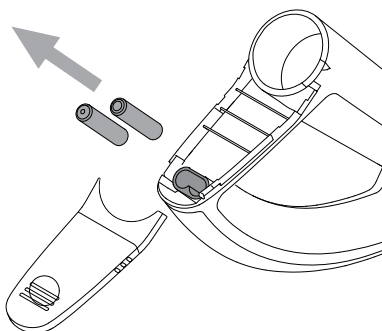
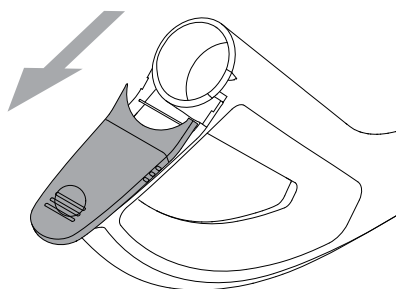

K

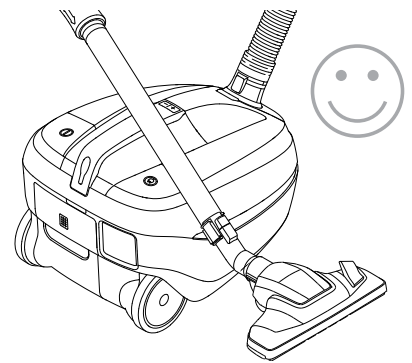
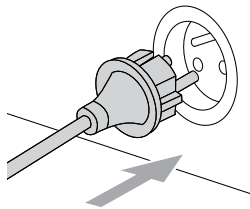
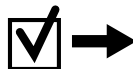
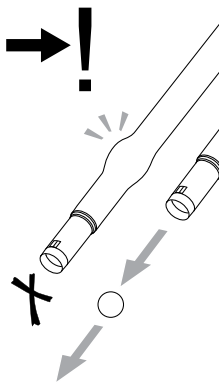
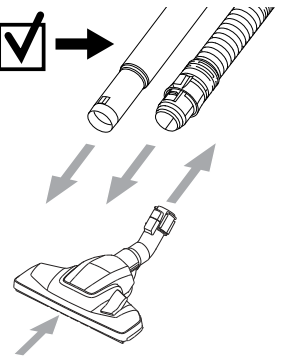
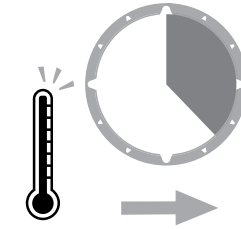
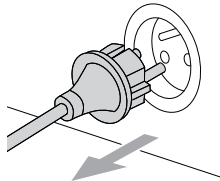
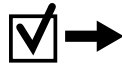
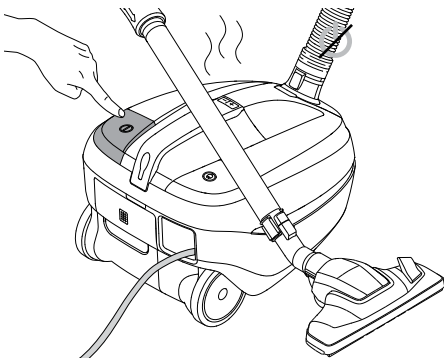

L

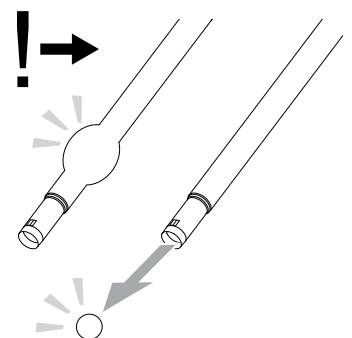
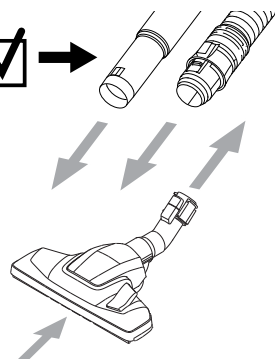
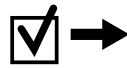
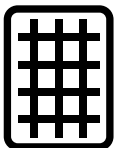
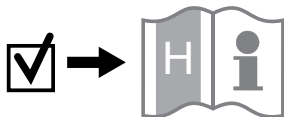
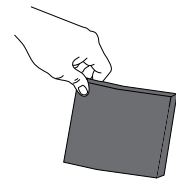
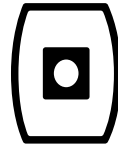
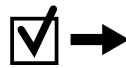
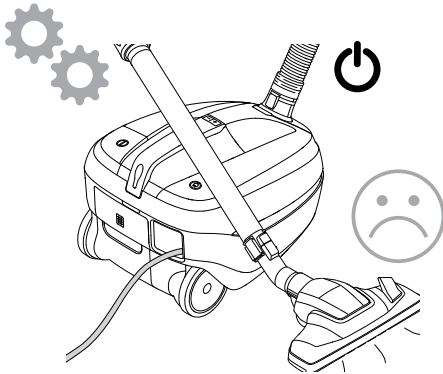

L

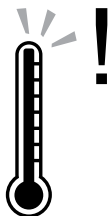
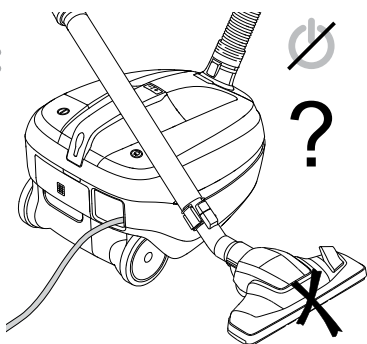

M

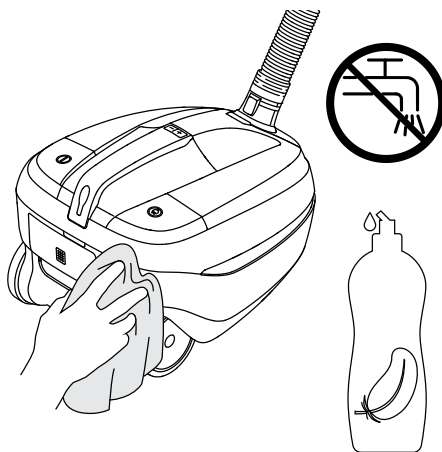
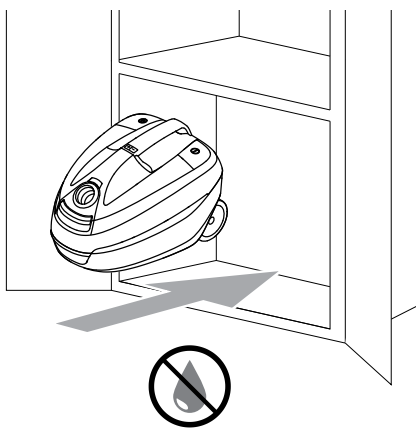

Declaração de conformidade

Nós,

Nilfisk A/S
Kornmarksvej 1
DK-2605 Broendby
DENMARK

declaramos por esta via que o

Produto: Aspirador - consumidor - seco com o
controle remoto sem fio
Descrição: 220-240V 50/60Hz, IPX0
Tipo: Select

cumprem as seguintes normas:

EN 60335-1:2012+A11:2014
EN 60335-2-2:2010+A11:2012+A1:2013
EN 55014-1:2006+A1:2009+A2:2011
EN 55014-2:2015
EN 61000-3-2:2014
EN 61000-3-3:2013
EN 50581:2012
EN 300 220-2 V3.1.1 Receiver Category 2
EN 301 489-1 V2.1.1
EN 301 489-3 V2.1.1
EN 60312-1:2017
EN 60704-2-1:2015

Segundo as disposições de:

2011/65/EU
2009/125/EC
666/2013/EU
2014/53/EU – Freq Band: 433MHz, TX: Max 0dBm

Hadsund, 04-12-2017



Esben Graff
VP Portfolio Management, Consumer



HEAD QUARTER

DENMARK

Nilfisk A/S
Kornmarksvej 1
DK-2605 Broendby
Tel.: (+45) 4323 8100
Website: www.nilfisk.com

SALES COMPANIES

ARGENTINA

Nilfisk srl.
Edificio Central Park
Herrera 1855, 6th floor/604
Ciudad de Buenos Aires
Tel.: (+54) 11 6091 1571
Website: www.consumer.nilfisk.com.ar

AUSTRALIA

Nilfisk Pty Ltd
Unit 1/13 Bessemer Street
Blacktown NSW 2148
Tel.: (+61) 2 98348100
Website: www.consumer.nilfisk.com.au

AUSTRIA

Nilfisk GmbH
Metzgerstrasse 68
5101 Bergheim bei Salzburg
Tel.: (+43) 662 456 400 90
Website: www.nilfisk.at

BELGIUM

Nilfisk n.v.s.a.
Riverside Business Park
Boulevard Internationellaan 55
Bâtiment C3/C4 Gebouw
Bruxelles 1070
Tel.: (+32) 24 67 60 50
Website: www.consumer.nilfisk.be

Brazil

Nilfisk do Brasil
Av. Eng. Luis Carlos Berrini, 550
40 Andar, Sala 03
SP - 04571-000 Sao Paulo
Tel.: (+11) 3959-0300 / 3945-4744
Website: www.nilfisk.com.br

CANADA

Nilfisk Canada Company
240 Superior Boulevard
Mississauga, Ontario L5T 2L2
Tel.: (+1) 800-668-8400
Website: www.nilfisk.ca

CHILE

Nilfisk S.A. (Comercial KCS Ltda)
Salar de Llamara 822
8320000 Santiago
Tel.: (+56) 2684 5000
Website: www.nilfisk.cl

CHINA

Nilfisk
4189 Yindu Road
Xinzhuang Industrial Park
201108 Shanghai
Tel.: (+86) 21 3323 2000
Website: www.nilfisk.cn

CZECH REPUBLIC

Nilfisk s.r.o.
VGP Park Horní Počernice
Do Čertous 1/2658
193 00 Praha 9
Tel.: (+420) 244 090 912
Website: www.consumer.nilfisk.cz

DENMARK

Nilfisk A/S
Kornmarksvej 1
2605 Broendby
Tel.: (+45) 4323 4050
Website: www.consumer.nilfisk.dk

FINLAND

Nilfisk Oy Ab
Koskelontie 23 E
02920 Espoo
Tel.: (+358) 207 890 600
Website: www.consumer.nilfisk.fi

FRANCE

Nilfisk SAS
26 Avenue de la Baltique
Villebon sur Yvette
91978 Courtaubouef Cedex
Tel.: (+33) 169 59 87 24
Website: www.consumer.nilfisk.fr

GERMANY

Nilfisk GmbH
Guido-Oberdorfer-Strasse 2-10
89287 Bellenberg
Tel.: (+49) (0)7306/72-444
Website: www.consumer.nilfisk.de

GREECE

Nilfisk A.E.
Αναπαύσεως 29
Κορωπί Τ.Κ. 194 00

Tel.: (30) 210 9119 600
Website: www.consumer.nilfisk.gr

HOLLAND

Nilfisk B.V.
Versterkerstraat 5
1322 AN Almere
Tel.: (+31) 036 5460760
Website: www.consumer.nilfisk.nl

HONG KONG

Nilfisk Ltd.
2001 HK Worsted Mills
Industrial Building
31-39, Wo Tong Tsui St.
Kwai Chung, N.T.
Tel.: (+852) 2427 5951
Website: www.nilfisk.com

HUNGARY

Nilfisk Kft.
II. Rákóczi Ferenc út 10
2310 Szigetszentmiklós-Lakihegy
Tel.: (+36) 24 475 550
Website: www.nilfisk.hu

INDIA

Nilfisk India Limited
Pramukh Plaza, 'B' Wing, 4th floor, Unit No. 403
Cardinal Gracious Road, Chakala
Andheri (East) Mumbai 400 099
Tel.: (+91) 22 6118 8188
Website: www.nilfisk.in

IRELAND

Nilfisk
1 Stokes Place
St. Stephen's Green
Dublin 2
Tel.: (+35) 3 12 94 38 38
Website: www.nilfisk.ie

ITALY

Nilfisk SpA
Strada Comunale della Braglia, 18
26862 Guardamiglio (LO)
Tel.: (+39) (0) 377 414021
Website: www.nilfisk.it

JAPAN

Nilfisk Inc.
1-6-6 Kita-shinyokohama, Kouhoku-ku
Yokohama, 223-0059
Tel.: (+81) 45548 2571
Website: www.nilfisk.com

MALAYSIA

Nilfisk Sdn Bhd
Sd 33, Jalan KIP 10
Taman Perindustrian KIP
Sri Damansara
52200 Kuala Lumpur
Tel.: +603 6275 3120
Website: www.nilfisk.com

MEXICO

Nilfisk de Mexico, S. de R.L. de C.V.
Pirneos #515 Int.
60-70 Microparque
Industrial WSantiago
76120 Queretaro
Tel.: (+52) (442) 427 77 00
Website: www.nilfisk.com

NEW ZEALAND

Nilfisk Limited
Suite F, Building E
42 Tawa Drive
0632 Albany Auckland
Tel.: (+64) 9 414 1996
Website: www.nilfisk.com

NORWAY

Nilfisk AS
Bjørnerudveien 24
1266 Oslo
Tel.: (+47) 22 75 17 80
Website: www.consumer.nilfisk.no

PERU

Nilfisk S.A.C.
Calle Boulevard 162, Of. 703, Lima 33- Peru
Lima
Tel.: (511) 435-6840
Website: www.nilfisk.com

POLAND

Nilfisk Sp. Z.O.O.
Millenium Logistic Park
ul. 3 Maja 8, Bud. B4
05-800 Pruszków
Tel.: (+48) 22 738 3750
Website: www.consumer.nilfisk.pl

PORTUGAL

Nilfisk Lda.
Sintra Business Park
Zona Industrial Da Abrunheira
Edifício 1, 1º A
P2710-089 Sintra
Tel.: (+351) 21 911 2670
Website: www.nilfisk.pt

RUSSIA

Nilfisk LLC

Vyatskaya str. 27, bld. 7/1st
127015 Moscow
Tel.: (+7) 495 783 9602
Website: www.consumer.nilfisk.ru

SINGAPORE

Den-Sin
22 Tuas Avenue 2
639453 Singapore
Tel.: (+65) 6268 1006
Website: www.densin.com

SLOVAKIA

Nilfisk s.r.o.
Bancíkovej 1/A
SK-821 03 Bratislava
Tel.: (+421) 910 222 928
Website: www.consumer.nilfisk.sk

SOUTH AFRICA

Nilfisk (Pty) Ltd
Kimbulk Office Park, 9 Zeiss Road
Laser Park, Honeydew
Johannesburg
Tel.: (+27) 118014600
Website: www.nilfisk.co.za

SOUTH KOREA

Nilfisk Korea
3F Duksoo B/D, 317-15
Sungsoo-Dong 2Ga
Sungdong-Gu, Seoul
Tel.: (+82) 2497 8636
Website: www.nilfisk.co.kr

SPAIN

Nilfisk S.A.U
Paseo del Rengle, 5 Planta. 9-10
08302 Mataró
Tel.: (+34) 93 741 2400
Website: www.consumer.nilfisk.es

SWEDEN

Nilfisk AB
Taljegårdsgatan 4
431 53 Mölndal
Tel.: (+46) 31 706 73 00
Website: www.consumer.nilfisk.se

SWITZERLAND

Nilfisk AG
Ringstrasse 19
Kircheberg/Industri Stelz
9500 Wil
Tel.: (+41) 71 92 38 444
Website: www.consumer.nilfisk.ch

TAIWAN

Nilfisk Ltd
Taiwan Branch (H.K)
No. 5, Wan Fang Road
Taipei
Tel.: (+88) 6227 00 22 68
Website: www.nilfisk.tw

THAILAND

Nilfisk Co. Ltd.
89 Soi Chokechai-Ruammitr
Viphavadee-Rangsit Road
Ladyao, Jatuchak, Bangkok 10900
Tel.: (+66) 2275 5630
Website: www.nilfisk.co.th

TURKEY

Nilfisk A.S.
Serifali Mh. Bayraktar Bulv. Sehit Sk. No:7
Ümraniye, 34775 Istanbul
Tel.: +90 216 466 94 94
Website: www.consumer.nilfisk.com.tr

UNITED ARAB EMIRATES

Nilfisk Middle East Branch
SAIF-Zone
P.O. Box 122298
Sharjah
Tel.: (+971) (0) 655-78813
Website: www.nilfisk.com

UNITED KINGDOM

Nilfisk Ltd.
Nilfisk House, Bowerbank Way
Gillwily Industrial Estate, Penrith
Cumbria CA11 9BQ
Tel.: (+44) (0) 1768 868995
Website: www.consumer.nilfisk.co.uk

UNITED STATES

Nilfisk Inc.
14600 21st Avenue North
Plymouth, MN-55447
Tel.: (+1) 800-989-2235
Website: www.nilfisk.com

VIETNAM

Nilfisk Vietnam
No. 51 Doc Ngu Str.
P. Vinh Phuc, Q.Ba Dinh
Hanoi
Tel.: (+84) 761 5642
Website: www.nilfisk.com

